



High-quality recycled plastics. Complete system solutions from one source.

»» Efficient recycling of plastics is an important part of the plastic industry's journey towards a circular economy. We help make designing, engineering, manufacturing, commissioning and operating your plastics recycling plant as efficient and simple as possible. By sourcing and implementing your complete system from a single supplier, you can easily achieve the high end product quality and throughput rates you expect.

KEY COMPONENTS FROM START TO FINISH

With Coperion, you can be sure that every key component required for efficient and cost-effective plastics recycling has been designed, developed, and produced by an industry leader, based on years of experience and unique process know-how. We provide comprehensive technology solutions to shred, fine grind and compact (agglomeration) clean production waste and to wash, separate and dry mixed and contaminated waste. From conveying of raw material, premixing, feeding, extruding,

compounding, pelletizing, classifying, drying and cooling, to gentle conveying, we have the right solution for all recycling applications. Whatever you require, every single sub-process will be optimally matched and seamlessly integrated into the overall process. The proof lies in Coperion's long history of providing complete systems, successfully commissioned and continuing to operate effectively and reliably for many years - producing high-quality products at the highest throughput rates.

THE COPERION DIFFERENCE

It's easy to see the difference a complete Coperion system can make in your operation. Firstly, its design and performance are individually tailored to meet your specific requirements. Secondly, it is comprised of high-quality key components manufactured in-house. And thirdly, from engineering to commissioning, everything is available from one convenient, reliable, experienced source: Coperion.

Our comprehensive process know-how enables us to design systems with a high degree of automation - delivering highest throughput rates with very high efficiency and consuming as little energy as possible. The result is a recycle with precisely the properties and the high quality required for the intended end product. However, it doesn't end there. With a global service network for your support, and test centers worldwide - including our Recycling Innovation Center - we continually strive to enhance and improve our systems, their performance, and your experience.

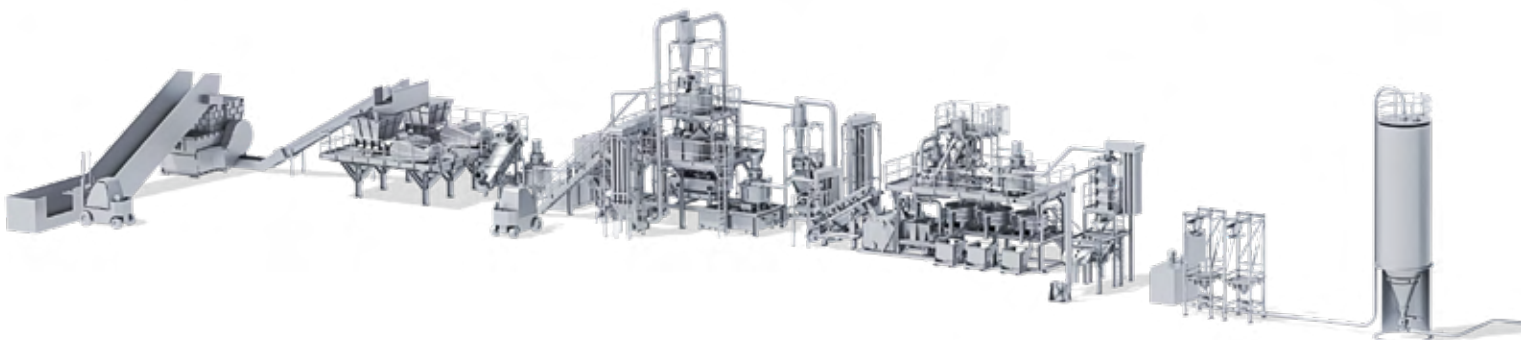

CLOSING THE LOOP WITH PLASTICS RECYCLING

The plastics industry is working towards achieving a circular economy. At Coperion our goal is to provide the support the industry needs to achieve this. Our first-class, efficient, and sustainable process solutions and technologies, across a comprehensive range of plastics recycling applications, will facilitate

the industry’s ability to meet its economic, ecological and social targets, for a sustainable long-term future. Coperion BlueValue recycling processes have been specifically developed to help our customers conserve resources, avoid waste, save energy, and reduce their carbon footprint.

>COPERION EXPERTISE

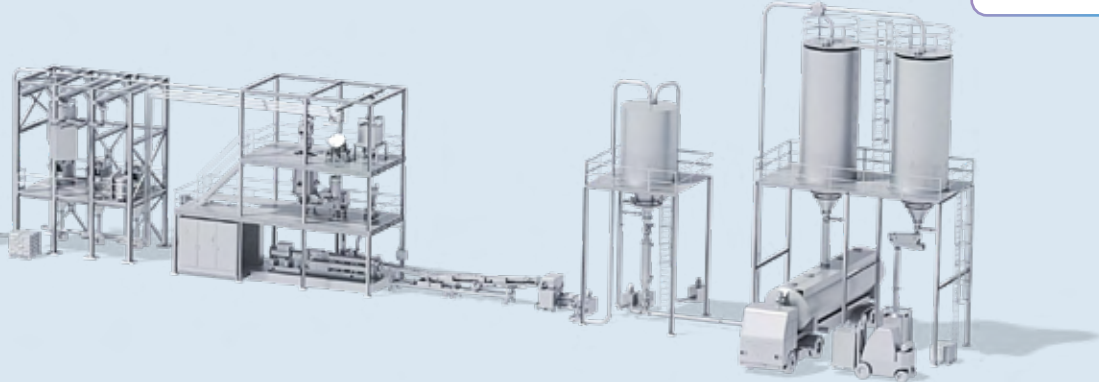
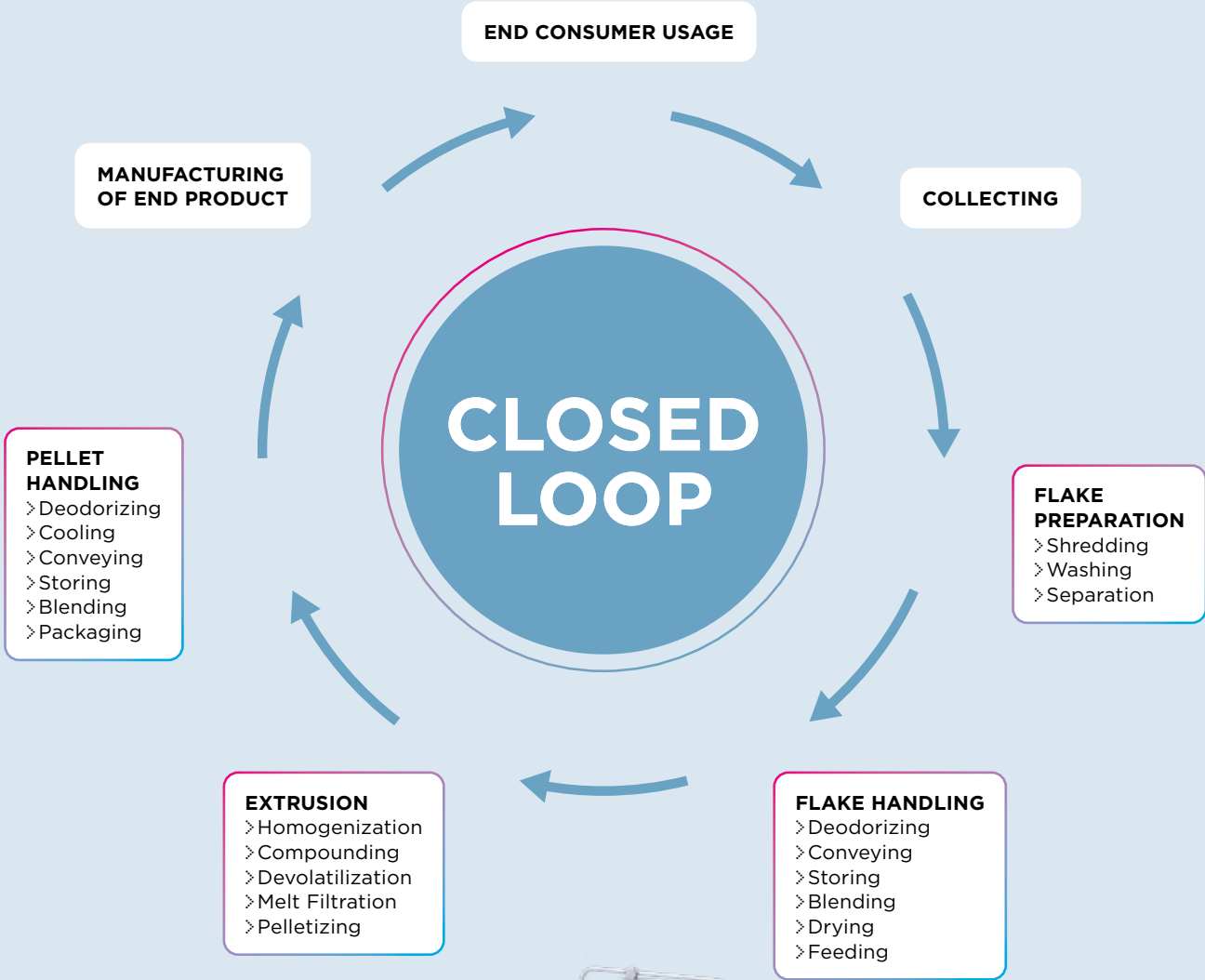

» Processes.

» MECHANICAL RECYCLING OF POST-CONSUMER/POST-INDUSTRIAL WASTE

Coperion offers numerous processes and technologies for mechanical recycling of post-consumer and post-industrial waste. In mechanical recycling, the polymer chain remains unchanged. This makes the process very energy-efficient. In addition to the

recycling of post-consumer packaging waste, further examples of innovative Coperion process solutions are the closed-loop process for recycling multi-layer films and the production of polyolefins with recycled content.

» POST-CONSUMER PACKAGING WASTE RECYCLING

All kinds of plastics in a wide variety of colors and shapes end up in consumer packaging waste. This mix of materials must be pre-sorted, shredded, washed, dried and finely sorted again. The single-sort material streams are then further processed with Coperion technologies. They are conveyed, dried, homogenized, deodorized and added to the ZSK twin screw

extruder via high-accuracy Coperion K-Tron feeders, along with additives, fillers and reinforcing materials. In the extruder, the material is melted, homogenized and degassed before finally being pelletized. Pneumatic conveying solutions transport the pellets to the desired destination. The recyclate can be deodorized, blended, dedusted, packed and loaded in trucks or trains.

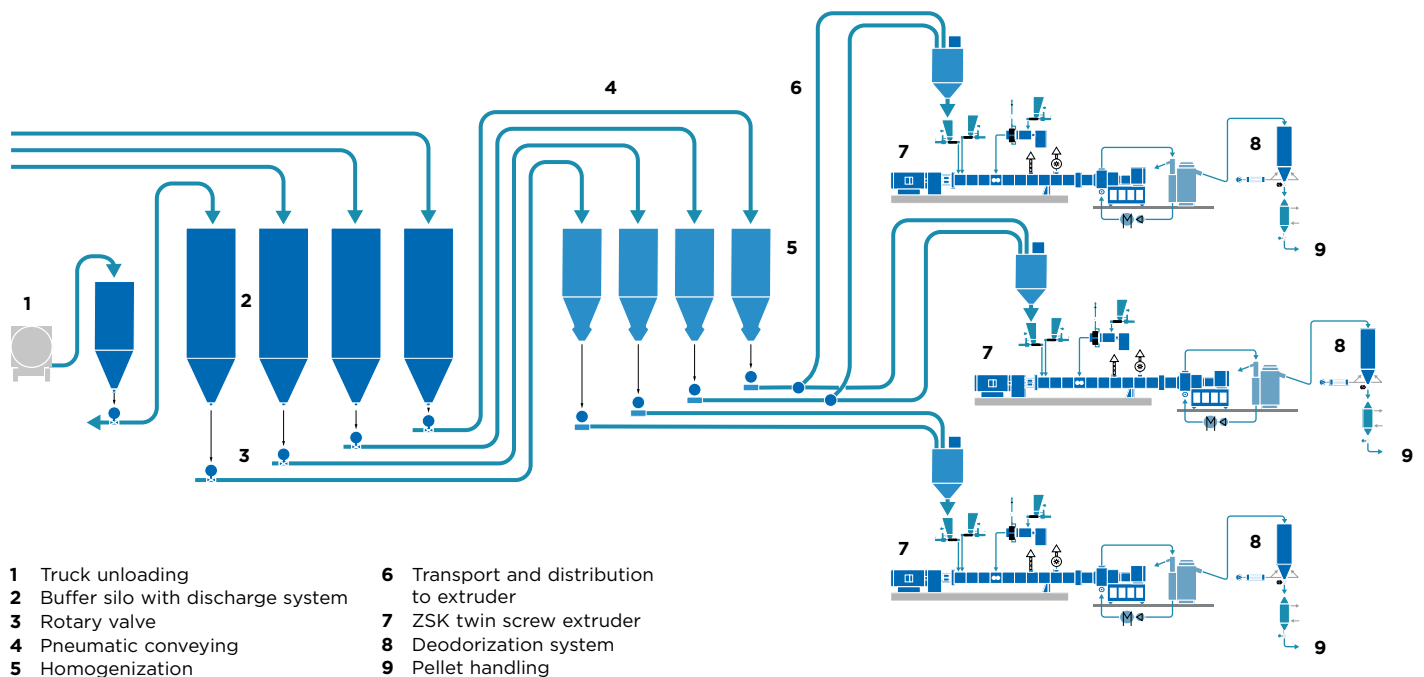

WHY CHOOSE COPERION'S SOLUTION?

- » Very high quality of the end product thanks to gentle product handling
- » Highly reliable technologies and process solutions
- » Highest throughput rates
- » Highly efficient processes (systems consume as little energy as possible, careful use of resources)
- » Turnkey solutions - from engineering to commissioning of a system, smooth integration of all process steps
- » High degree of system automation
- » Reliable and proven solution for the handling of PCR flakes, including rotary valves, degassers, mixers and dryers
- » ZS-B MEGAfeed side feeder for reliable feeding of plastic flakes and fibers with bulk densities starting as low as 20 kg/m³ into the ZSK extruder
- » Very high accuracy, even when feeding materials with fluctuating bulk density thanks to Coperion K-Tron gravimetric feeders
- » High end product quality thanks to very gentle product handling, short residence time, and very good dispersion in the ZSK extruder
- » Very intensive degassing within the ZSK extruder with the aid of stripping agents for very high end product quality
- » Devolatilization system for efficient, safe removal of solvent residues to increase product quality

› MULTI-LAYER FILM RECYCLING

The recycling of multi-layer films has long been a challenge, as these films can only be recycled at great expense and not without residues. Coperion offers a closed-loop solution in which

up to 100 percent of the production waste from multi-layer films can be recycled and returned to the production stream.

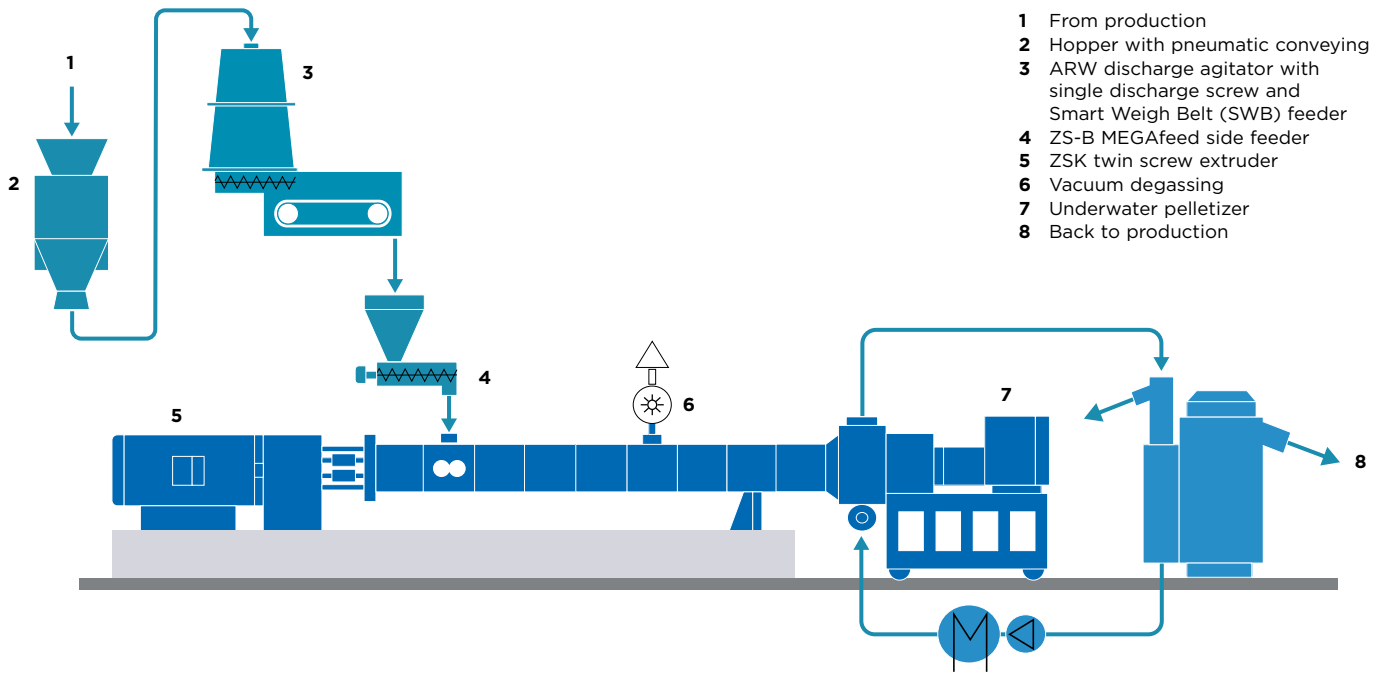

WHY CHOOSE COPERION'S SOLUTION?

- › Production waste from multi-layer films can be recycled and returned to the production process, achieving very high recycling rates
- › Discharge agitator ARW for safe discharge of difficult-to-handle film scraps with very low bulk densities
- › Compact design of the Coperion K-Tron Smart Weigh Belt (SWB) feeder reduces the overall height requirement, offering associated cost advantages
- › ZS-B MEGAfeed side feeder for reliable feeding of large quantities of plastic flakes into the ZSK twin screw extruder
- › First-class homogenization and dispersion of a wide variety of polymers within the ZSK twin screw extruder
- › Intensive degassing within the ZSK extruder for maximum product quality
- › Gentle product handling even at highest throughput rates, resulting in consistently high end product quality

CASE STUDY

A customer has installed a Coperion multi-layer film recycling system to return recycled post-industrial waste to the production stream. Compared with conventional single screw extruder recycling processes, the customer realizes energy savings of 30 percent, while also producing a very high-quality recycle. The high proportion of recycled production waste significantly reduces the customer's carbon footprint.



» Processes.

» POLYOLEFIN PRODUCTION WITH MECHANICAL RECYCLATE CONTENT

Conventional processes for the production of polyolefins with recyclate content involve three steps: preparation of the virgin raw material; mechanical recycling, filtration and pelletizing of plastic waste; blending of the two product streams. Coperion's innovative process solution allows the mechanically recycled

and filtered melt to be fed directly into the extruder which produces virgin material - with no need for a further energy-intensive step to mix and melt virgin material stream and PCR compounds.

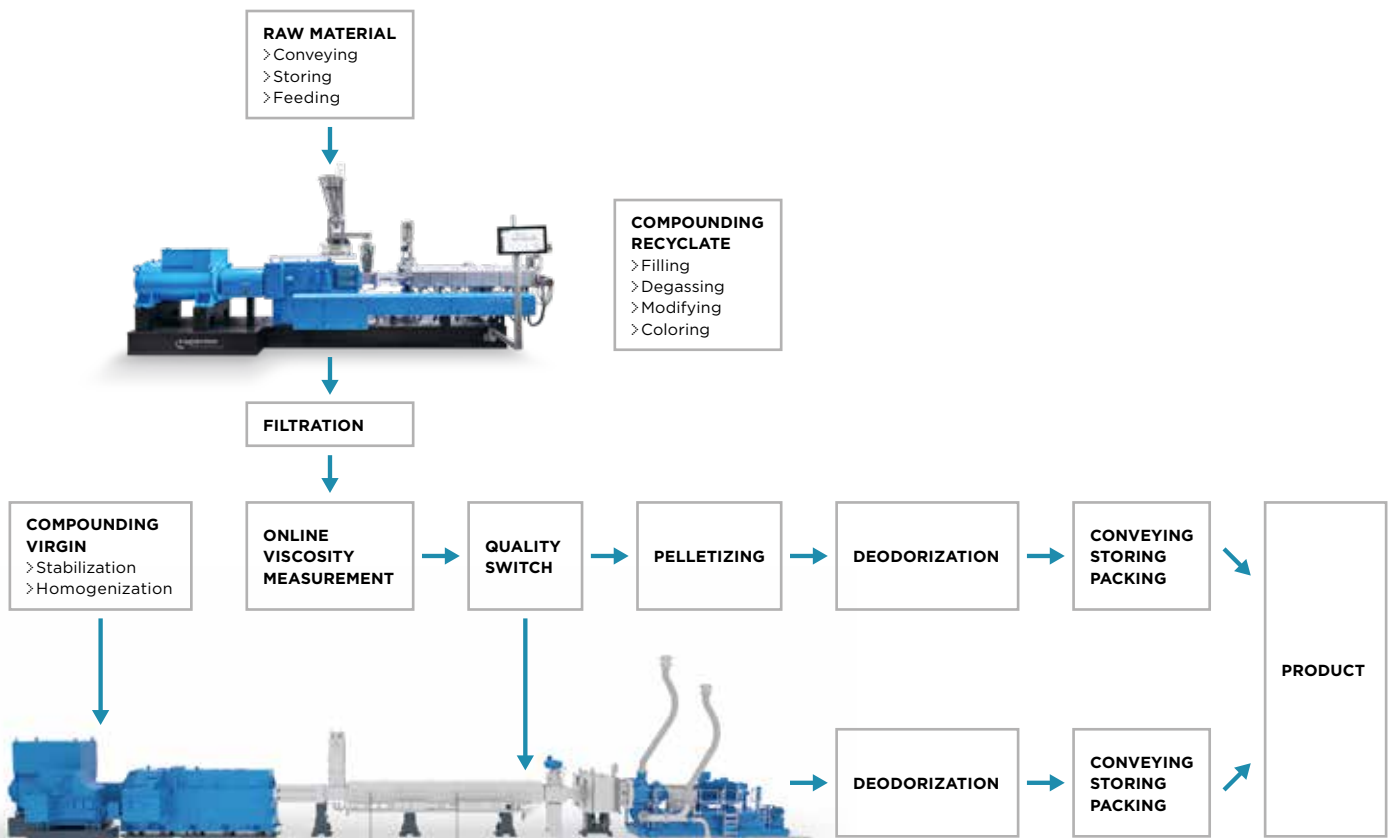

WHY CHOOSE COPERION'S SOLUTION?

- » Reduction of production and logistics costs
- » Enormous energy savings, as re-melting of the PCR compounds and virgin material is eliminated. Polyolefin compounds with recycled content can be produced in one heating operation
- » Online quality measurement and evaluation to check the quality of the PCR product stream
- » If needed, the technology for the production of blended grades can also be operated separately, to produce virgin and pure PCR grades
- » Existing virgin polyolefin plants can be retrofitted with this technology, requiring only minor modifications to the existing polyolefin extrusion line
- » Comprehensive process know-how of an industry leader for polyolefin production systems

› CHEMICAL RECYCLING

Plastic waste is not a simple substance. Usually - especially true of packaging waste - it is a mix of different materials with a high level of impurities. Recycling these materials into chemicals, waxes or liquid energy sources is a challenge. But it is one which Coperion is meeting, through innovation in reliable, economical solutions for chemical recycling.

- 1 Feeding of post-consumer waste
- 2 ARW discharge agitator with single discharge screw and Smart Weigh Belt (SWB) feeder
- 3 ZS-B MEGAfeed side feeder
- 4 ZSK twin screw extruder
- 5 Gravimetric feeder for additives
- 6 Vacuum degassing
- 7 Reactor
- 8 Distillator

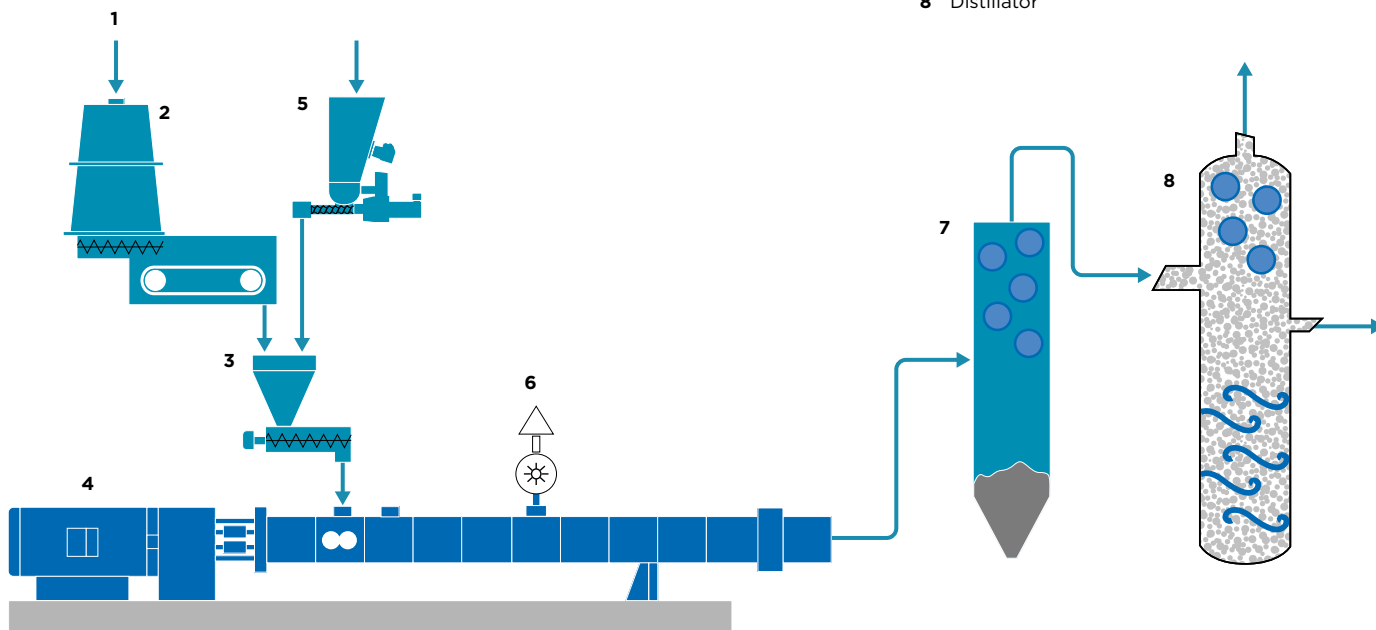

WHY CHOOSE COPERION'S SOLUTION?

- › Throughputs from 100 kg/h to 20 t/h
- › FLUIDLIFT® ecodry process for efficient drying of surface moisture and conveying in a single process step - resulting in more energy-efficient vacuum technology at the extruder
- › Discharge agitator ARW with dosing screw conveyor DSR and Smart Weigh Belt (SWB) feeder for reliable discharge and high-accuracy feeding of difficult-to-handle products, resulting in a stable feed into the reactor even when recycling material with fluctuating bulk density
- › ZS-B MEGAfeed side feeder for economically viable recycling of plastic flakes and fibers with bulk densities starting as low as 20 kg/m³
- › High-accuracy feeding of additives (e.g. catalysts) using Coperion K-Tron feeders
- › Optimized dissipation with ZSK twin screw extruder. Lower energy consumption compared with pyrolysis process without extruder, or processing with single screw extruder
- › Highly energy-efficient process, thanks to the operation principle of the ZSK twin screw extruder, which introduces energy via shear and friction, rather than by heat conduction
- › Optimal homogenization of all materials within the ZSK twin screw extruder - including all types of polymers with a wide range of viscosities
- › Efficient degassing of the melt in the ZSK extruder - especially when residual water or chlorides from PVC are present - creating optimal conditions for the pyrolysis process

Processes.

➤ SOLVENT-BASED RECYCLING

For energy- and cost-efficiency, as well as a high-quality end product, solvent-based recycling is hard to beat.

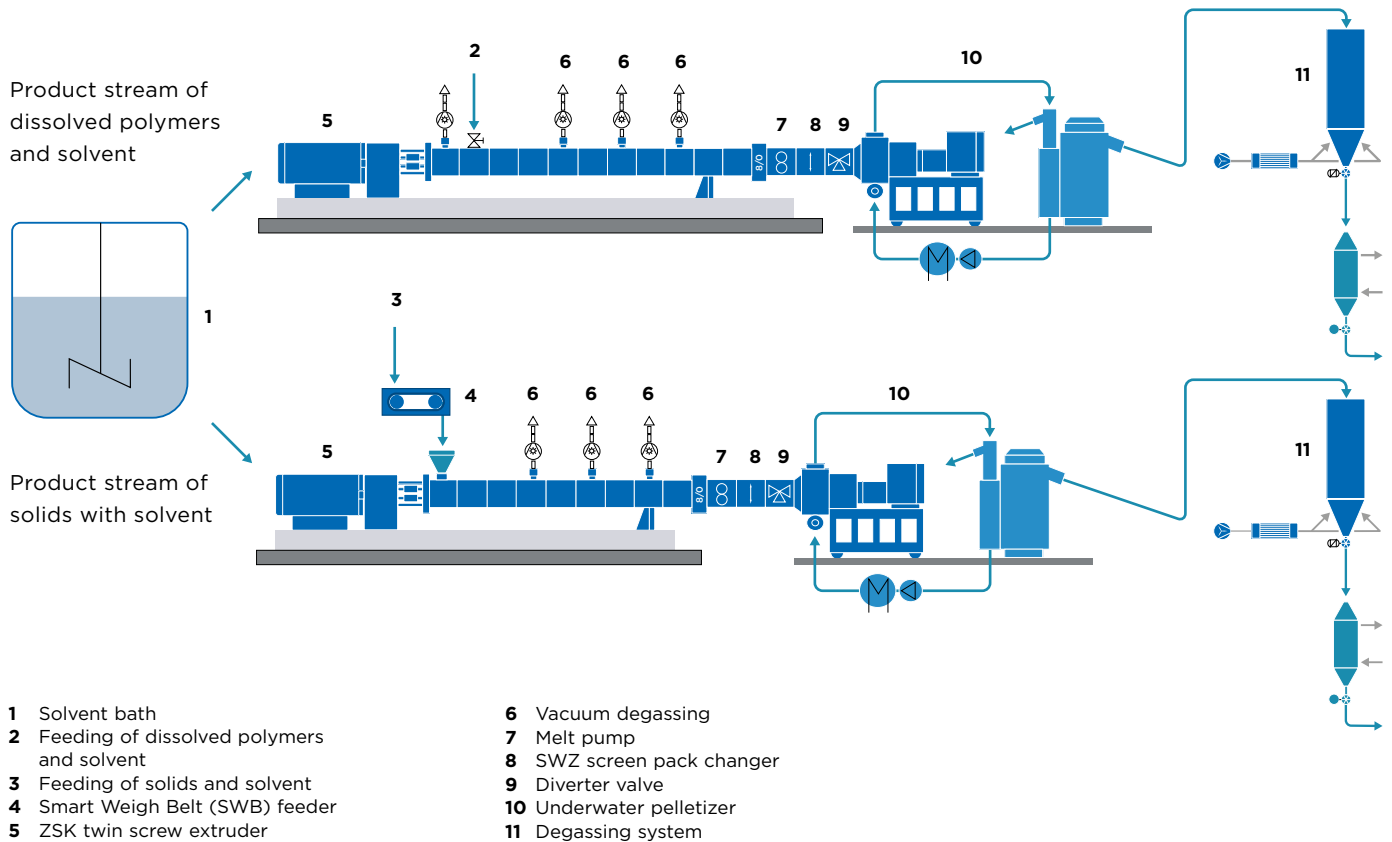

WHY CHOOSE COPERION'S SOLUTION?

➤ Handling and homogenization of bulk materials upstream and downstream of the extruder including storage of flakes, reliable silo discharge, blending and gentle pneumatic conveying

➤ Very high degassing performance in the ZSK twin screw extruder ensures high product quality
 ➤ Degassing system following pelletizing for efficient, safe removal of solvent residues to increase product quality

➤ PET RECYCLING

PET is a high-value material which is increasingly important in the plastics industry's move towards a circular economy. Whether you are recycling bottle-to-bottle, bottle-to-film/sheet, bottle-to-fiber, or PET from other product streams,

PET has excellent recycling properties. Its growing use in disposable and reusable bottles – and its recovery via deposit systems – continues to add to its value.

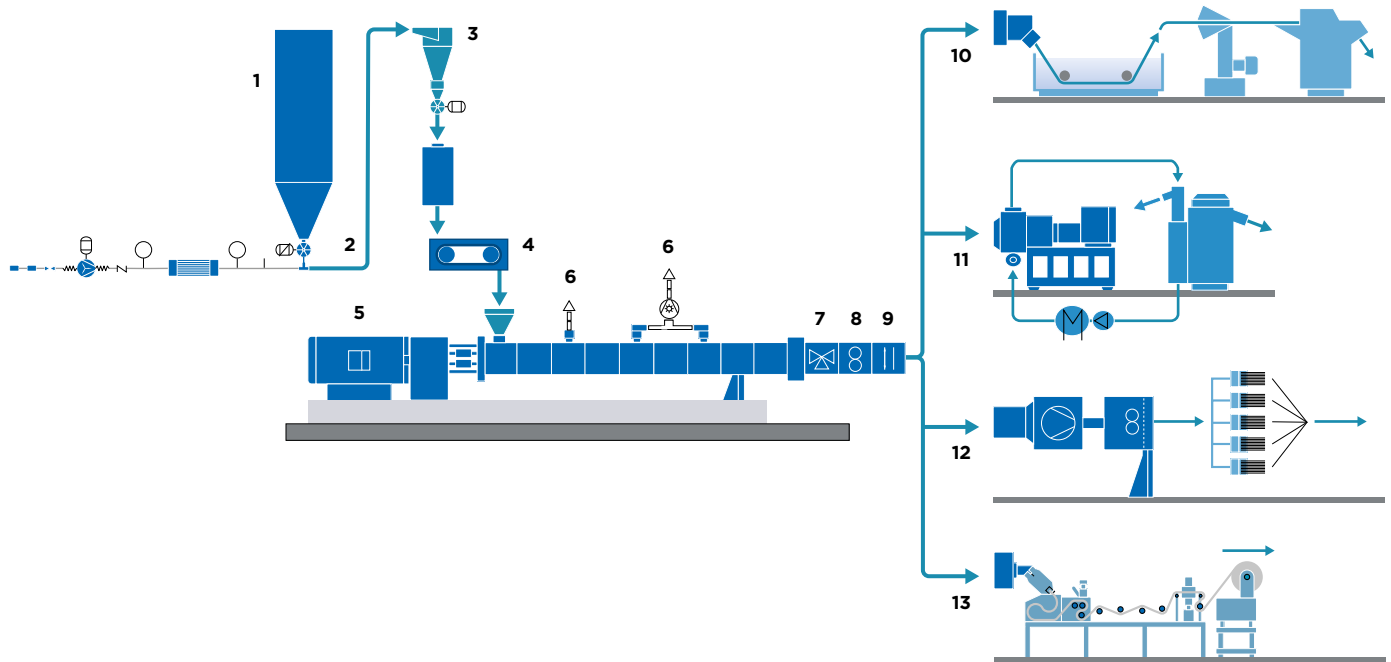

- | | |
|--|--|
| 1 Buffer silo with discharge system and rotary valve for PET flakes | 7 Diverter valve |
| 2 FLUIDLIFT® ecodry | 8 Melt pump |
| 3 Cyclone | 9 SWZ screen pack changer |
| 4 Smart Weigh Belt (SWB) feeder | 10 Water bath and strand pelletizer |
| 5 ZSK twin screw extruder | 11 Underwater pelletizer |
| 6 Degassing | 12 Fiber spinning pumps |
| | 13 Film stretching line |

WHY CHOOSE COPERION'S SOLUTION?

- Very high throughputs of up to 10 t/h
- High end product quality due to very gentle product handling, short residence time, intensive degassing, and excellent dispersion in the ZSK twin screw extruder
- PET recyclates produced with Coperion recycling technology and decontaminated in an SSP (Solid State Polycondensation) reactor have been approved by the U.S. Food and Drug Administration (FDA) for direct contact with foodstuffs and feature an increased iV value
- Virgin material and various recyclates (regrind, agglomerates, flakes) can be processed together, even if they have different iV values
- Savings in operating and energy costs as well as lower logistical effort compared with conventional PET recycling processes
- FLUIDLIFT® ecodry process for efficient drying of surface moisture and conveying of bottle flakes in a single process step – resulting in more energy-efficient vacuum technology at the extruder
- High-accuracy Coperion K-Tron feeding solutions – even for high material temperatures
- ZS-B MEGAfeed side feeder for reliable feeding of large quantities of plastic flakes and fibers with bulk densities starting as low as 20 kg/m³
- Very high specific torque of the ZSK extruder makes it possible to process at low temperatures with only minimal iV degradation
- High flexibility, as formulations and colors can be changed very quickly due to the good self-cleaning action of the ZSK's twin screws

» Processes.

» PARTIAL GLYCOLYSIS OF PET

This process involves the homogeneous mixing of ethylene alcohol into the PET melt inside the ZSK extruder. This cleaves the PET polymer chains and reduces the molecular weight and the viscosity, so that the melt can be very finely filtered, and impurities can be easily removed. Two options for use of the melt are possible, depending on the application. Either it can

be fed to a polycondensation reactor, for homogenization with a virgin PET stream and consequent rebuilding of the PET chain length. Or, it can be further depolymerized and purified to bis(hydroxyethyl)terephthalate (BHET), then polymerized back to PET.

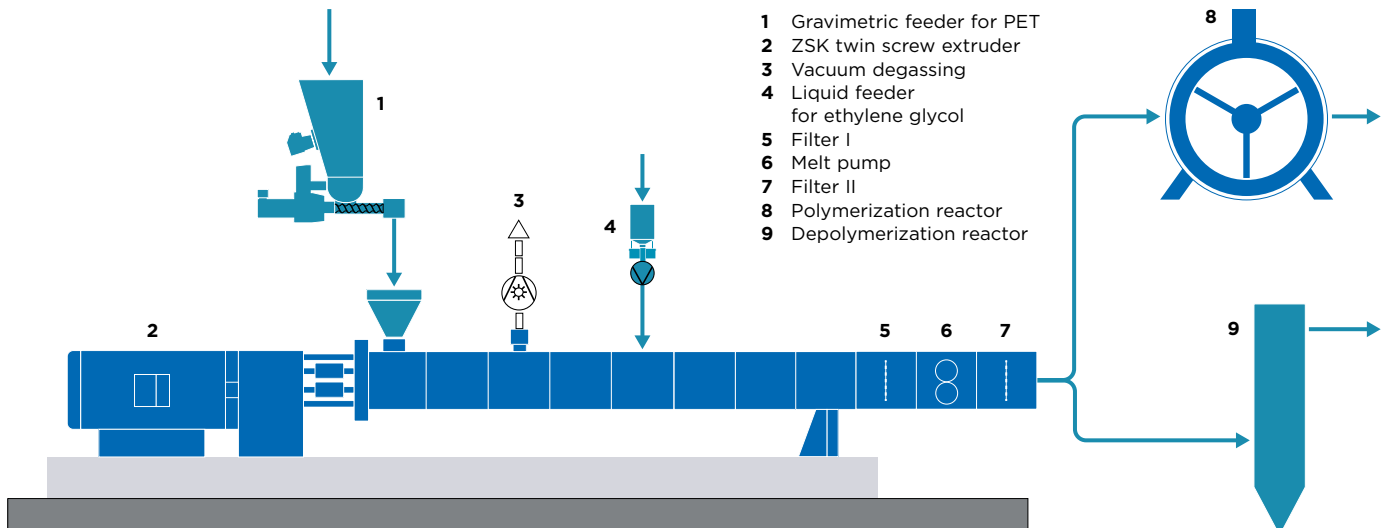

WHY CHOOSE COPERION'S SOLUTION?

- » High end product quality due to very gentle product handling and short residence time (approx. 30 seconds) in the ZSK extruder
- » Throughput rates up to 10,000 kg/h with one extruder
- » Highly energy-efficient process, thanks to the operation principle of the ZSK twin screw extruder, which introduces energy via shear and friction, rather than by heat conduction
- » Savings in operating and energy costs as well as reduced logistical effort compared with conventional PET recycling processes, since pre-drying and crystallization are not required
- » ARW discharge agitator for reliable discharge of difficult-to-handle products
- » High-accuracy Coperion K-Tron weighing technology for reliable feeding of all types of bulk materials, including irregular shapes

MODERNIZING YOUR SYSTEM

Your current system can be modified to allow virgin material to be combined with recyclate. Based on our extensive process engineering know-how we are able to retrofit existing technologies and systems, allowing large proportions of recyclate to be incorporated into your plastics production and processing, with no compromise on the quality of the end product. We can retrofit material handling and feeding systems to process recyclates, and extruders and pelletizers to deliver the product quality required. By implementing our comprehensive zero-waste modernization measures, you can recycle your production waste back into the production process.



› DEODORIZATION SYSTEMS

Plastic recyclates often have an unpleasant odor. If they are intended for use in manufacturing new products – as well as other applications – this must be eliminated to allow the recyclate to meet both sensory and mechanical requirements. Coperion offers two innovative methods for odor elimination that can also be combined for maximum efficiency: devolatilization within the ZSK extruder and deodorization systems. Deodorization systems devolatilize bulk materials following the extrusion process, by continuously degassing the recycled compounds. Product quality is determined – and can be optimized – by considering the parameters for residence time, temperature, and gas quantity. Different systems are available, tailored to the customer’s requirements, with capacities ranging from a few hundred kilos per hour to several tons per hour. In some cases Coperion’s BULK-X-CHANGE® heat exchanger can be used to heat and cool the recyclate in order to speed-up odor reduction.

A mobile version of the deodorization systems allows for intensive testing on location and facilitates direct specification of odor reduction capabilities at any plastic recyclate production plant.

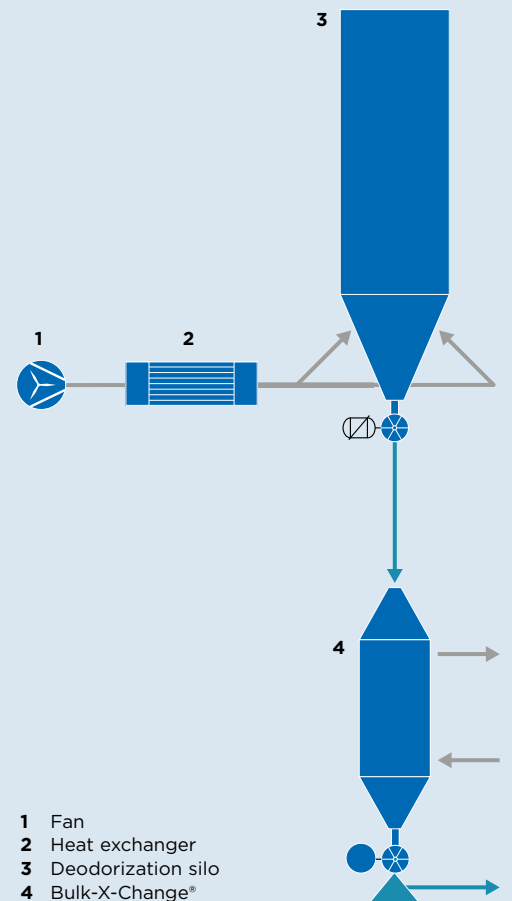

» Technologies for innovative process solutions. Key components of Coperion process solutions are the result of our own unique innovation. These technologies are designed for treatment of clean production waste as well as mixed and contaminated waste. We offer solutions for conveying, premixing, feeding, extruding, compounding, pelletizing, classifying, drying, cooling, and packaging the finished products.

ZSK TWIN SCREW EXTRUDER

ZSK twin screw extruders are at the heart of every plastic recycling process. Their powerful processing properties and high devolatilization performance make ZSK twin screw extruders suitable for the energy-efficient recycling of all types of plastics. The ZSK extruder reliably ensures very high product qualities at the highest rates of throughput.



> ZSK 70 Mc¹⁸ TWIN SCREW EXTRUDER IDEAL FOR RECYCLING OF VARIOUS PLASTICS



GRANULATOR SML 60/100 SB 2

The Herbold Meckesheim granulator is suitable for wet operation with horizontal forced feeding by means of screw conveyors, which allows space-saving installations and easy feeding of the material. Another advantage is the high throughput capacity: The SB mill can process up to two tons of polyolefins per hour or well over one ton of film. SB granulators are also often used for grinding PET bottles and in washing plants for plastics recycling. In addition, the mill is characterized by uniform load absorption and low energy consumption, and all wear parts are easily replaceable.



MATERIAL HANDLING

The widely varying properties of recycled materials such as regrind, flakes and fibers often make them extremely difficult to handle. Decades of experience with more than 10,000 bulk materials means we understand the challenges very well. Our process engineers are experts at finding the right solution for bulk material handling both before and after the extrusion process (pneumatic conveying, discharging, homogenizing, drying, deodorizing and more). We will not only help to ensure your plant's safe and economical operation, but also the reliable manufacture of your end product to the desired quality.

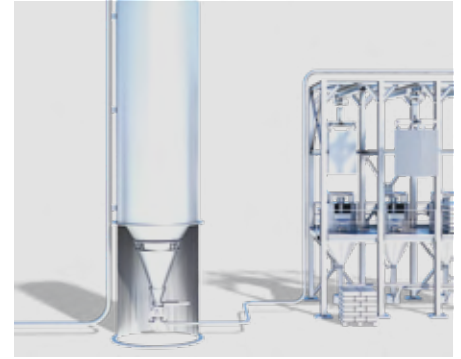

FLUIDLIFT® ecodry

A highly energy-efficient flash-drying process to reduce the moisture remaining in the recycling regrind from the washing process, combined with transportation to the extruder. Reduction of the moisture content by up to 5% before extrusion leads to an improvement in end product quality.



ARW DISCHARGE SILO

An inverted conical silo with agitator, for the discharge of non-free-flowing bulk materials. This can be combined with a screw conveyor or discharge airlock. Special relief cones for non-free flowing bridging material promote consistent and stable product discharge.



SMART WEIGH BELT (SWB) FEEDER

A low height gravimetric feeder, which feeds large volumes of bulk material with high accuracy. Even materials with a wide range of flow properties and bulk densities, such as flakes and fluff, are fed with high accuracy.



ZS-B MEGAfeed SIDE FEEDER

An innovative side feeder for economically viable recycling of plastic flakes and fibers with bulk densities starting as low as 20 kg/m³. Previously considered feed-limited, these can be reliably fed into the ZSK twin screw extruder in large quantities, for recycling and simultaneous compounding at high throughput rates.

»» Test centers. With extensively equipped test centers located around the world, Coperion and Coperion K-Tron can test and resolve process challenges before any investment has been made.

Product behavior, new formulations and equipment modifications for conveying, feeding, extruding, and compounding applications can be extensively tested under real production

conditions. In adjoining laboratories, product qualities and properties can be comprehensively analyzed.

INNOVATING FOR A CIRCULAR ECONOMY

Leading the way in the development and testing of new, sustainable products and recycling processes, Coperion's Recycling Innovation Center has been specially designed for the recycling of plastics and associated research activities. All essential stages of the recycling process are covered within the facility, including raw material conveying, premixing, feeding, extruding, compounding, pelletizing, classifying, drying, cooling as well as conveying and packaging of the finished products.

Working with partner company Herbold Meckesheim - which has its own test center for upstream processes - Coperion is closing the loop on testing for plastics recycling. The whole process can be tested prior to any financial commitment for a wide variety of recycling applications.

» COPERION'S RECYCLING INNOVATION CENTER AND FURTHER TEST CENTERS WORLDWIDE



» Worldwide service network. Coperion offers customers a world of support, to ensure the continued reliable and efficient operation of their recycling plants.

There is more to service than just maintenance and repair. To maximize reliability, optimize efficiency and provide customers with a real advantage in the face of tough competition, equipment needs to be serviced by skilled personnel with in-depth expertise and extensive experience. Coperion operates

a network of almost 30 service centers worldwide, staffed by over 350 service engineers and technicians, and accessible via a 24/7 service hotline - helping you to realize at all times the full potential of Coperion technology and innovation in your recycling plant.

WE ARE WHERE YOU ARE

SERVICE HOTLINE

24/7

available worldwide

SERVICE CENTERS

29

service centers worldwide

SERVICE NETWORK

350

service engineers and technicians worldwide

» COPERION'S SERVICE NETWORK OFFERS CUSTOMERS WORLDWIDE SUPPORT



Coperion GmbH

Theodorstrasse 10
70469 Stuttgart, Germany
Tel.: +49 711 897-0
Fax: +49 711 897-3999

Coperion GmbH

Niederbieger Strasse 9
88250 Weingarten, Germany
Tel.: +49 751 408-0
Fax: +49 751 408-200

Coperion K-Tron Salina, Inc.

606 North Front Street
Salina, KS 67401, USA
Tel.: +1 785 825-1611
Fax: +1 785 825-8759

Coperion K-Tron Salina, Inc. Sewell Office

590 Woodbury Glassboro Road
Sewell, NJ 08080, USA
Tel.: +1 856 589-0500
Fax: +1 856 589-8113

Coperion K-Tron (Schweiz) GmbH

Lenzhardweg 43/45
5702 Niederlenz, Switzerland
Tel.: +41 62 885-7171
Fax: +41 62 885-7180

info@coperion.com
www.coperion.com

>Europe

Belgium, Luxembourg, Netherlands
Coperion N.V.
Industrieweg 2, 2845 Niel, Belgium
Tel.: +32 3 870-5100
Fax: +32 3 877-0710

France

Coperion S.a.r.l.
56 boulevard de Courcerin
77183 Croissy-Beaubourg, France
Tel.: +33 164 801 600
Fax: +33 164 801 599

Germany

Coperion GmbH
Germany West Office
Industriestrasse 71a
50389 Wesseling, Germany
Tel.: +49 2232 20700-10
Fax: +49 2232 20700-11

Coperion Pelletizing Technology GmbH

Heinrich-Krumm-Strasse 6
63073 Offenbach, Germany
Tel.: +49 69 989 5238-0
Fax: +49 69 989 5238-25

Coperion K-Tron Deutschland GmbH

Heinrich-Krumm-Strasse 6
63073 Offenbach, Germany
Tel.: +49 69 8300 899-0
Fax: +49 69 8300 9498

Italy

Coperion S.r.l.
Via E. da Rotterdam, 25
44122 Ferrara, Italy
Tel.: +39 0532 7799-11
Fax: +39 0532 7799-80

Coperion S.r.l.

Milan Office
Via XXV Aprile, 49
20091 Bresso (MI), Italy
Tel.: +39 02 241 049-01
Fax: +39 02 241 049-22

Russian Federation, CIS

OOO Coperion
Proezd Serebryakova 14,
Bld. 15, Office 219
129343 Moscow, Russian Federation
Tel.: +7 499 258 4206
Fax: +7 499 258 4206

Spain, Portugal

Coperion, S.L.
Balmes, 73, pral.
08007 Barcelona, Spain
Tel.: +34 93 45173-37
Fax: +34 93 45175-32

United Kingdom

Coperion Ltd.
Coperion K-Tron Great Britain Ltd.
Unit 4, Acorn Business Park
Heaton Lane
Stockport, SK4 1AS, United Kingdom
Tel.: +44 161 209 4810
Fax: +44 161 474 0292

>Asia

China

Coperion (Nanjing) Machinery Co. Ltd.
No. 1296 Jiyin Avenue
Jiangning District
Nanjing 211106, PR China
Tel.: +86 25 5278 6288
Fax: +86 25 5261 1188

Coperion (Nanjing) Machinery Co. Ltd.

Taiwan Branch Office
7F-2, No.201, Fuxing N. Road
Songsshan District
Taipei City 105403, Taiwan
Tel.: +886 2 2547 5267
Fax: +886 2 2547 5980

Coperion International Trading (Shanghai) Co. Ltd.

Coperion Machinery & Systems (Shanghai) Co. Ltd.
3rd Floor, Building B1
6000 Shenzhuan Road
Dongjing Town, Songjiang District
Shanghai 201619, PR China
Tel.: +86 21 6767 9505
Fax: +86 21 6767 9108

Coperion K-Tron (Shanghai) Co. Ltd.

3rd Floor, Building B1
6000 Shenzhuan Road
Dongjing Town, Songjiang District
Shanghai 201619, PR China
Tel.: +86 21 6767 9505
Fax: +86 21 6767 9108

India

Coperion Ideal Pvt. Ltd.
Ideal House, A-35, Sector 64
201307 Noida (U.P.), India
Tel.: +91 120 4299 333
Fax: +91 120 4308 583

Japan

Coperion K.K.
4F, Leaf Square Shin-Yokohama Bldg.
3-7-3, Shin-Yokohama,
Kohoku-ku Yokohama,
Kanagawa 222-0033, Japan
Tel.: +81 45 595 9801
Fax: +81 45 595 9802

Saudi Arabia

Coperion Middle East Co. Ltd.
Street # 327, Sector G, Block 2, Lot # 31
Jubail 2 Industrial City,
Kingdom of Saudi Arabia
Tel.: +966 13 510 4420
Fax: +966 13 510 4421

Singapore

Coperion Pte. Ltd.
Coperion K-Tron Asia Pte. Ltd.
8 Jurong Town Hall Road
#28-01/02/03 The JTC Summit
Singapore 609434
Tel.: +65 641 88-200
Fax: +65 641 88-203

>America

South America

Coperion Ltda.
R. Arinos, 1000
RBCA - Royal Business Center
Anhanguera, Módulo 4
Parque Industrial Anhanguera
06276-032 Osasco - SP, Brazil
Tel.: +55 11 3874-2740
Fax: +55 11 3874-2757

USA, Canada, Mexico, NAFTA

Coperion Corporation
590 Woodbury Glassboro Road
Sewell, NJ 08080, USA
Tel.: +1 201 327-6300
Fax: +1 201 825-6494

Coperion Corporation Wytheville Office

196 Appalachian Drive
Wytheville, VA 24382, USA
Tel.: +1 276 228-7717
Fax: +1 276-227-7044

Coperion Corporation Houston Office

5825 North Sam Houston Pkwy West
Suite 250
Houston, TX 77086, USA
Tel.: +1 281 449-9944
Fax: +1 281 449-4599

For more information about
the worldwide Coperion network,
visit www.coperion.com